

Bora electric





Bora

Ref.	A mm	B mm	Elem. n.	White & Colors	Chrome & Galvanics	Weight kg
				Power Heater + fan W	Power Heater + fan W	
BORAIR2092050F	1000	500	19	500+1000		16,0
BORAIR2120050F	1260	500	27	750+1000		20,5

WALL FASTENING SYSTEMS

Fissaggi a parete
Systèmes d'installation murale
Sistemas de fijación a la pared

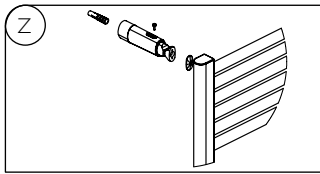

RADIATOR BODY DIMENSIONS

Dimensioni corpo
Dimensions du corps chauffant
Dimensiones del cuerpo calefactor

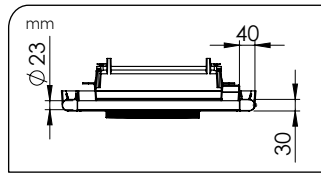

THERMOSTAT

Termostato
Thermostat
Termostato

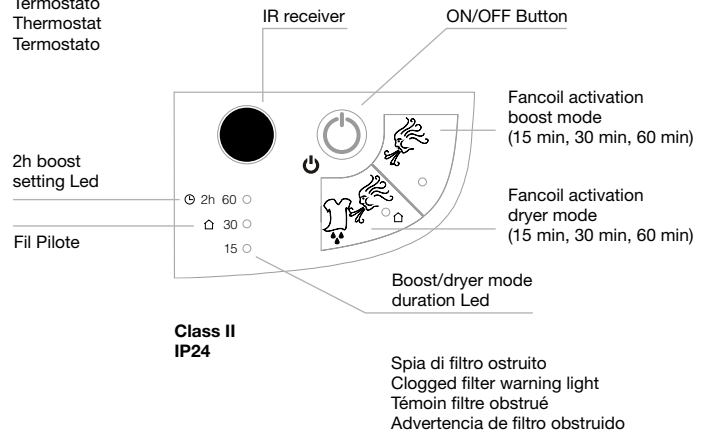

A = altezza; B = larghezza
A = height; B = width
A = hauteur; B = largeur
A = altura; B = ancho

[mm]

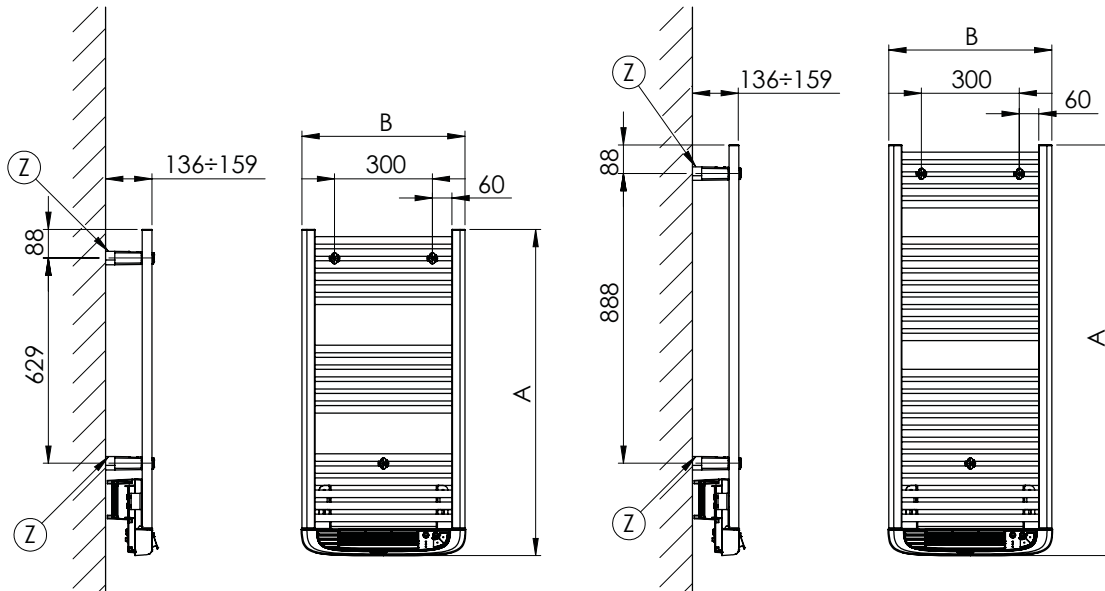

TECHNICAL NOTES

Lunghezza cavo 0,7 mt dotato di Europlug
Cable length 0,7 mt with Europlug
Longueur du câble 0,7 m avec Europlug
Longitud del cable 0,7 mt con Europlug

Alimentazione 230V - 50Hz
230V - 50Hz power supply
Alimentation 230V - 50Hz
Alimentación 230V - 50Hz





DELTACALOR

Company profile

Quality made in Italy

The company was founded in the mid-nineties with a traditional handcraft steel towel rail production. In 2002 the company was transformed into a real industrial reality, following the acquisition of an important group in view of the plumbing and heating sector led by CEO Giovanni Pastorino who decides to revive the company renewing its product range with new ranges of hydraulic, mixed and electrical steel towel warmers and radiators with exclusive technology and design. Deltacalor is strongly characterized by a 360° approach that incorporates technology, practicality and aesthetics. The constant Research and Development on materials, shapes, finishes and processes leads the company to the launch of major patented products, tangible evidence of real and concrete innovations. Not only the heating elements, but also expression of an innate attitude in the search of the best way to provide comfort and well-being at the service of man. High functionality, energy saving, easy installation, high quality are, in fact, the advantages of a production able to meet and anticipate the needs of designers, architects, installers and end users.

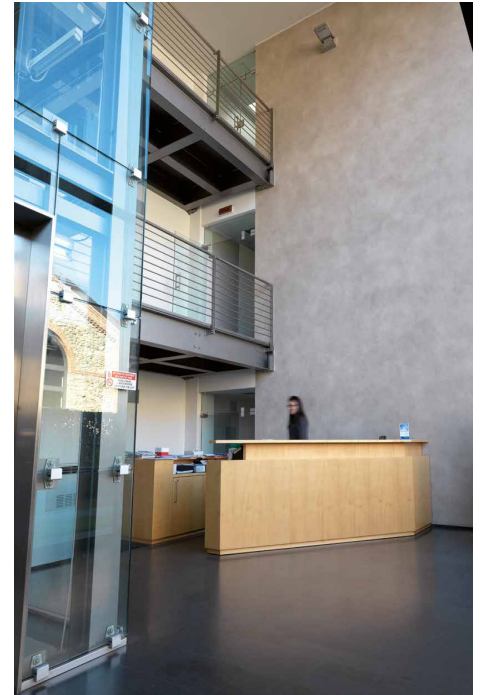



DELTACALOR

Company profile

Production takes place in Italy

Production takes place in Italy, in the state of the art plant of Calolziocorte (LC), on a surface of approximately 10,000 sqm. We use the most innovative and advanced production methods: from welding to painting, to a well established quality control system based on the highest market standards. Production know-how is one of Deltacalor strengths: the company can produce a high number of parts using highly automated systems, but is also capable of meeting the different degrees of customisations that the market requires. All this, with the utmost attention to process control, ensured by a team of experienced professionals.

Deltacalor takes advantage of a young and dynamic workforce of 50 employees, capable of meeting all the needs of our customers, and ready to take on the challenges of the market. This is the winning combination of the company that always ensures precise and timely service.



White
Standard
Deltacolor white



Chrome

Pastels
Coarse or Matt

9016
Traffic white



1013
Oyster white



1019
Grey beige



7006
Beige grey



7030
Stone grey

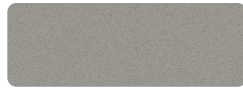

7047
Telegrey 4

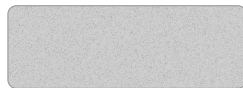

7040
Window grey



7043
Traffic grey B



9005
Jet black



Specials
Coarse



7048
Pearl mouse grey



2
Quartz sand



6
Quartz gray

by
Andrea Castriano



10
Army



11
Petrol

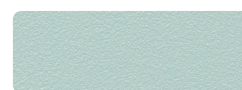

12
Laguna



13
Balena



14
Rouille

Plate Lux
(Inox Steel Cover)

Flowered



Gold mirror



Black mirror



Copper mirror



Galvanics

Glossy or Matt



British Gold



Bronze Copper



Astana Brass

colors

Non considerare i colori perfettamente fedeli per limiti di stampa e illuminazione.

Do not consider colors as exactly trustable because of printing and light limits.

Ne pas considérer les couleurs comme exactement correspondants suite à limites de imprimerie et de lumière.

No tenir en consideracion los colores como perfectamente igual para limitaciones de imprenta y de luz.